

MOTOR SPECIFICATION SHEET

MODEL : SF-QRGH 5HP 4P RATIO 1:30 (LT)

USED FOR : GEAR MOTOR

DESCRIPTION	DETAIL			
PHASE	3			
MODEL NAME	SF-QRGH			
RATED OUTPUT, HP (kW)	5 (3.7)			
POLE	4			
CODE	MEATH CODE : 1G7030-0370N-LTQR0			
OUTLINE DRAWING NO.	ONM14O344-A			
RATED VOLTAGE (V)	220	380	415	
RATED FREQUENCY (Hz)	50	50	50	
RATED CURRENT (A)	14.0	8.1	8.0	
RATED SPEED (min ⁻¹)	50	50	50	
RATED EFFICIENCY (%)	83.1	83.1	83.2	
EFFICIENCY CLASS	IE1			
THERMAL CLASS	155(F)			
RATING	S1 (CONTINUOUS)			
ENCLOSURE CONSTRUCTION	TOTALLY ENCLOSED FAN COOLED			
DEGREES OF PROTECTION	IP55			
METHOD OF COOLING	IC411			
FRAME NO.	112M			
WEIGHT (kg)	81			
STANDARD	IEC 60034-1, IEC 60034-30-1			
INSTALLATION	FOOT MOUNTED			
ROTATION	CCW (VIEWED FROM SHAFT END)			
BEARING	LOAD SIDE : 6308ZZ			
	OPPOSITE SIDE : 6206ZZ			
BEARING GREASE	UREA GREASE			
CIRCUMSTANCE CONDITION	AMBIENT TEMPERATURE : -20 ~ +40°C			
	AMBIENT HUMIDITY : 95%RH OR LESS			
	ABOVE SEA LEVEL : 1000m OR LESS			
	ENVIRONMENT : NO BURSTING/EROSIVE GAS OR VAPOR			
COLOR	MUNSELL N1.5 (BLACK)			
TERMINAL BOX	NO. OF LEAD WIRES : 6			
	SOURCE CONNECTION : TERMINAL BLOCK			
GEAR RATIO	1:30			
GEAR LUBRICANT	GREASE (Filled from factory.)			
SERVICE FACTOR	1.4			
MATERIAL	FRAME : STEEL PLATE			
	BRACKET (GEAR SIDE) : N/A (Frame is directly connected to Gear case)			
	BRACKET (OPP SIDE) : ALUMINIUM			
	GEAR CASE : CAST IRON			
	SHAFT (MOTOR) : STEEL			
	SHAFT (GEAR OUTPUT) : STEEL			
	STATOR CORE : ELECTRICAL STEEL			
	WIRE : ENAMELLED COPPER MAGNET WIRE			
	ROTOR CORE : ELECTRICAL STEEL			
	CONDUCTOR : ALUMINIUM			
	TERMINAL BOX : STEEL PLATE			
	PAINTING : POLYURETHANE RESIN			
PRODUCTION COUNTRY	THAILAND			

Specifications subject to change without notice.

SPECIFICATION SHEET NO.

SS-M-1914-B

MODEL SF-QRGH THREE PHASE INDUCTION MOTOR OUTLINE DRAWING

GEAR MOTOR
 TOTALLY ENCLOSED FAN COOLED
 DEGREES OF PROTECTION IP55
 DUST & WATER JET PROOF

CUSTOMER _____
 USER _____
 FOR _____
 CUSTOMER'S ORDER NO. _____
 QUANTITY _____
 MFG. ORDER NO. _____

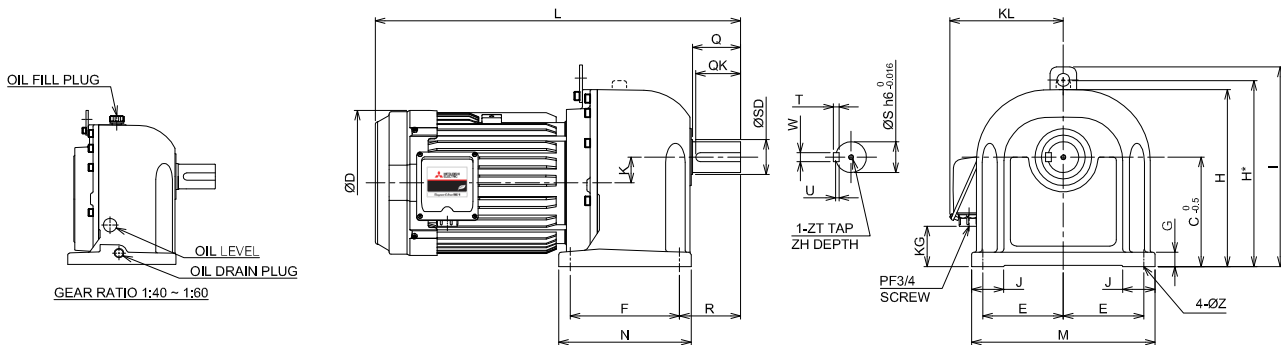

YOUR ORDER	GEAR RATIO	DIMENSION(mm.)																				WEIGHT (kg.)					
		L	Q	QK	ØD	K	F	R	N	T	W	U	ZT	ZH	ØS	ØSD	KL	KG	J	E	M		G	C	H	I	ØZ
	1:3~1:30	568	75	70	228	40	170	95	206	9	14	5.5	M8	12	48	50	178	78	50	125	285	22	170	275	310	15	81
	1:40,1:50	609	82	71	228	50	200	107	240	10	16	6	M10	18	55	58	178	93	60	130	300	25	195	330*	345	19	98
	1:60	642.5	90	72	228	60	230	120	280	11	18	7	M10	18	60	63	178	118	70	150	350	30	230	380*	395	24	125

YOUR ORDER	MOTOR FRAME SIZE	RATING	TH. CLASS	AMB. TEMP	BEARINGS		COLOR	GEAR RATIO	DIRECTION OF ROTATION (VIEWED FROM SHAFT END)	NO. OF LEAD WIRES	REMARKS
					LOAD SIDE	OPP. SIDE					
	112M	S1 (CONT.)	155(F)	40°C	6308ZZ	6206ZZ	BLACK (MUNSELL N1.5)	1:3	CW	6	
							1:5~1:30	CCW			
							1:40~1:60	CW			

YOUR ORDER	RATIO	SERVICE FACTOR	MOTOR OUTPUT		POLE	VOLT	HERTZ	OUTPUT SPEED (min ⁻¹)	AMP.	IE CODE - RATED EFF.	TYPE	LUBRICATION TYPE
			HP	kW								
	1:3	1.4	5	3.7	4	220/380/415	50	485/485/490	14.0/8.1/8.0	IE1 - 83.1%/83.1%/83.2%	LT	GREASE ⁽¹⁾
	1:5	1.4	5	3.7	4	220/380/415	50	300/300/305				
	1:10	1.4	5	3.7	4	220/380/415	50	142/142/143				
	1:15	1.4	5	3.7	4	220/380/415	50	99/99/99				
	1:20	1.4	5	3.7	4	220/380/415	50	70/70/70.5				
	1:25	1.4	5	3.7	4	220/380/415	50	56.5/56.5/57				
	1:30	1.4	5	3.7	4	220/380/415	50	50/50/50				
	1:40	1.4	5	3.7	4	220/380/415	50	34.5/34.5/34.5				
	1:50	1.4	5	3.7	4	220/380/415	50	30/30/30				
	1:60	1.4	5	3.7	4	220/380/415	50	23/23/23				
	1:3	1.4	5	3.7	4	380/415	50	485/490	8.1/8.0	IE1 - 82.7%/82.7%	HT	GREASE ⁽¹⁾
	1:5	1.4	5	3.7	4	380/415	50	300/305				
	1:10	1.4	5	3.7	4	380/415	50	142/143				
	1:15	1.4	5	3.7	4	380/415	50	99/99				
	1:20	1.4	5	3.7	4	380/415	50	70/70.5				
	1:25	1.4	5	3.7	4	380/415	50	56.5/57				
	1:30	1.4	5	3.7	4	380/415	50	50/50				
	1:40	1.4	5	3.7	4	380/415	50	34.5/34.5				
	1:50	1.4	5	3.7	4	380/415	50	30/30				
	1:60	1.4	5	3.7	4	380/415	50	23/23				

NOTE : (1) GREASE HAD BEEN FILLED FROM MANUFACTURER ALREADY.
 (2) PLEASE FILL IN OIL BEFORE FIRST TIME USAGE. (SEE DETAIL IN THE INSTRUCTION MANUAL)

MITSUBISHI ELECTRIC AUTOMATION (THAILAND) CO.,LTD.

	OUTLINE DRAWING NO.	REV.
	DIMENSION IN mm.	
SCALE : NTS		